

PG2S,PH2S,PGXS,PHXS,PMG2S

Montageanleitung Installation Manual

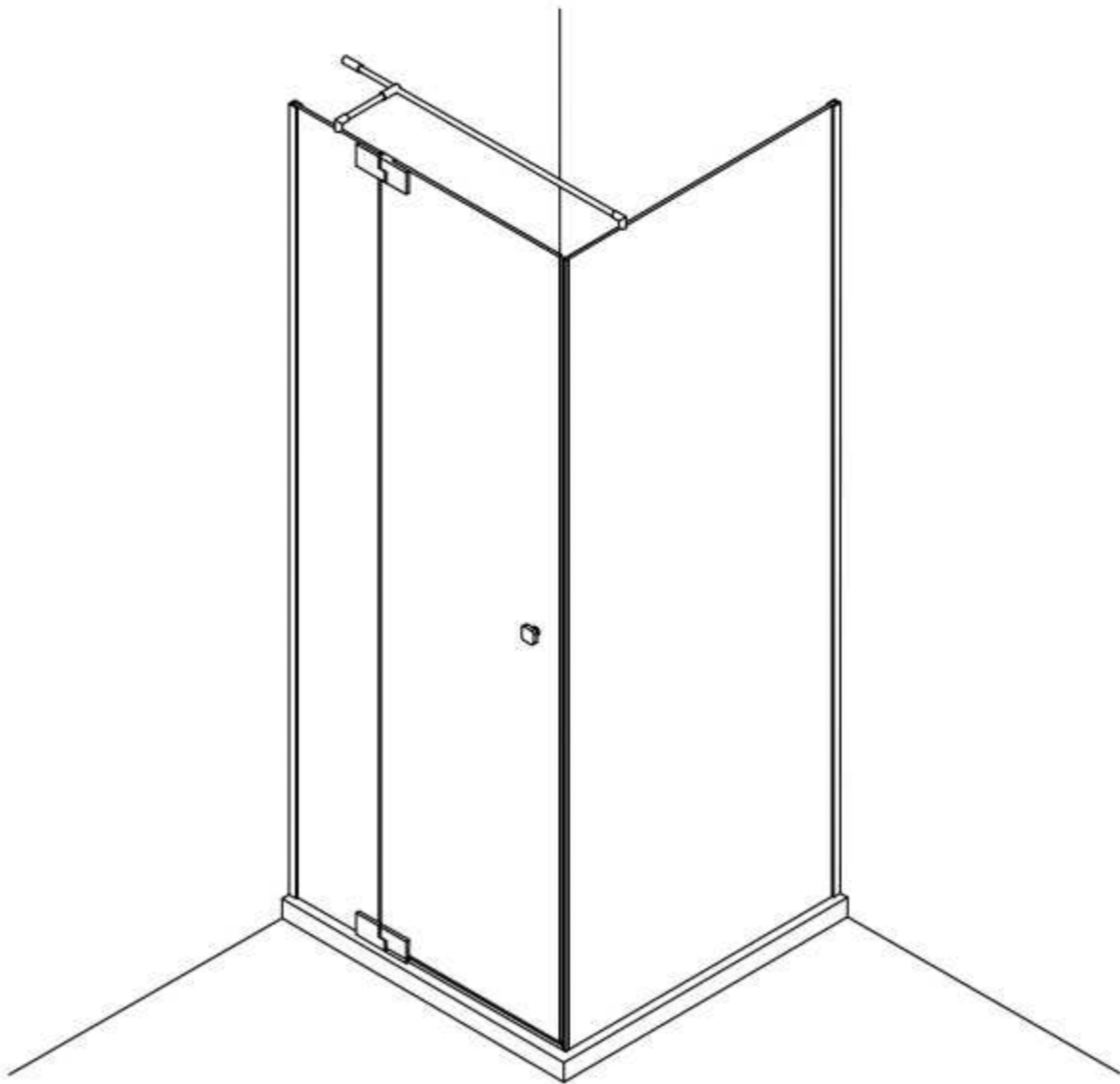

Eck-Dusche mit Festwand
Corner shower enclosure with fixed side panel
Rechts / Right

1 x G/GS-LO		1 x G2/G2H		4 x G100		8 x	1 x
1 x G/GS-LU		1 x G3/G3H		4 x G300		8 x	4 x C2
2 x P/WKP		1 x G8/G8H		1 x G400		4 x	8 x d
1 x G/SUT120 1 x G/SUP40		1 x G10		2 x	1 x		

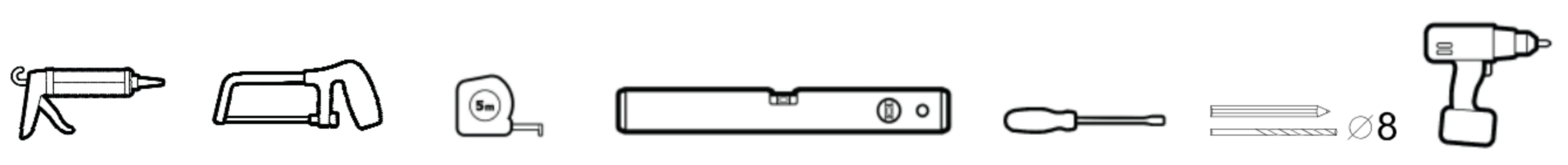
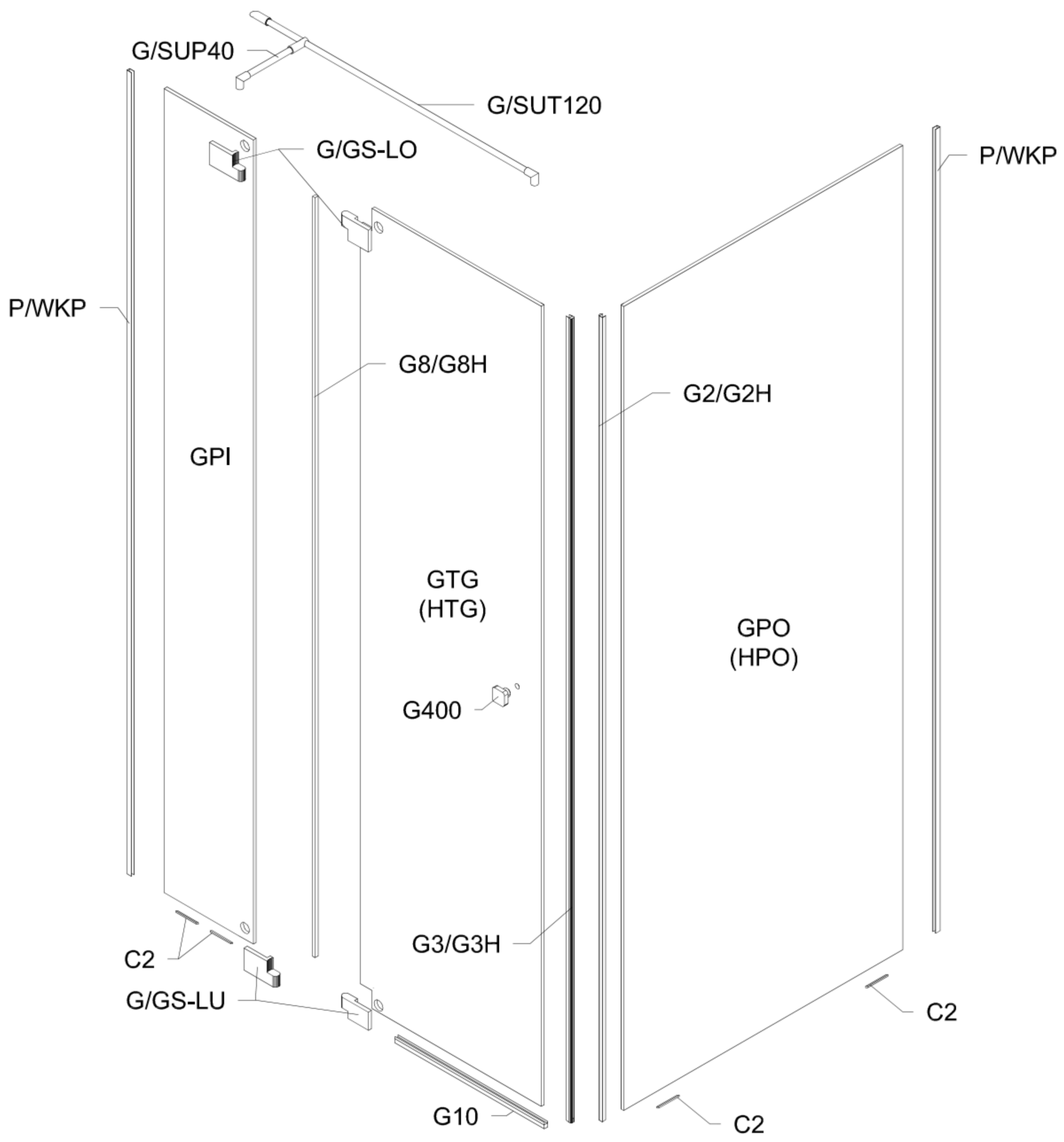

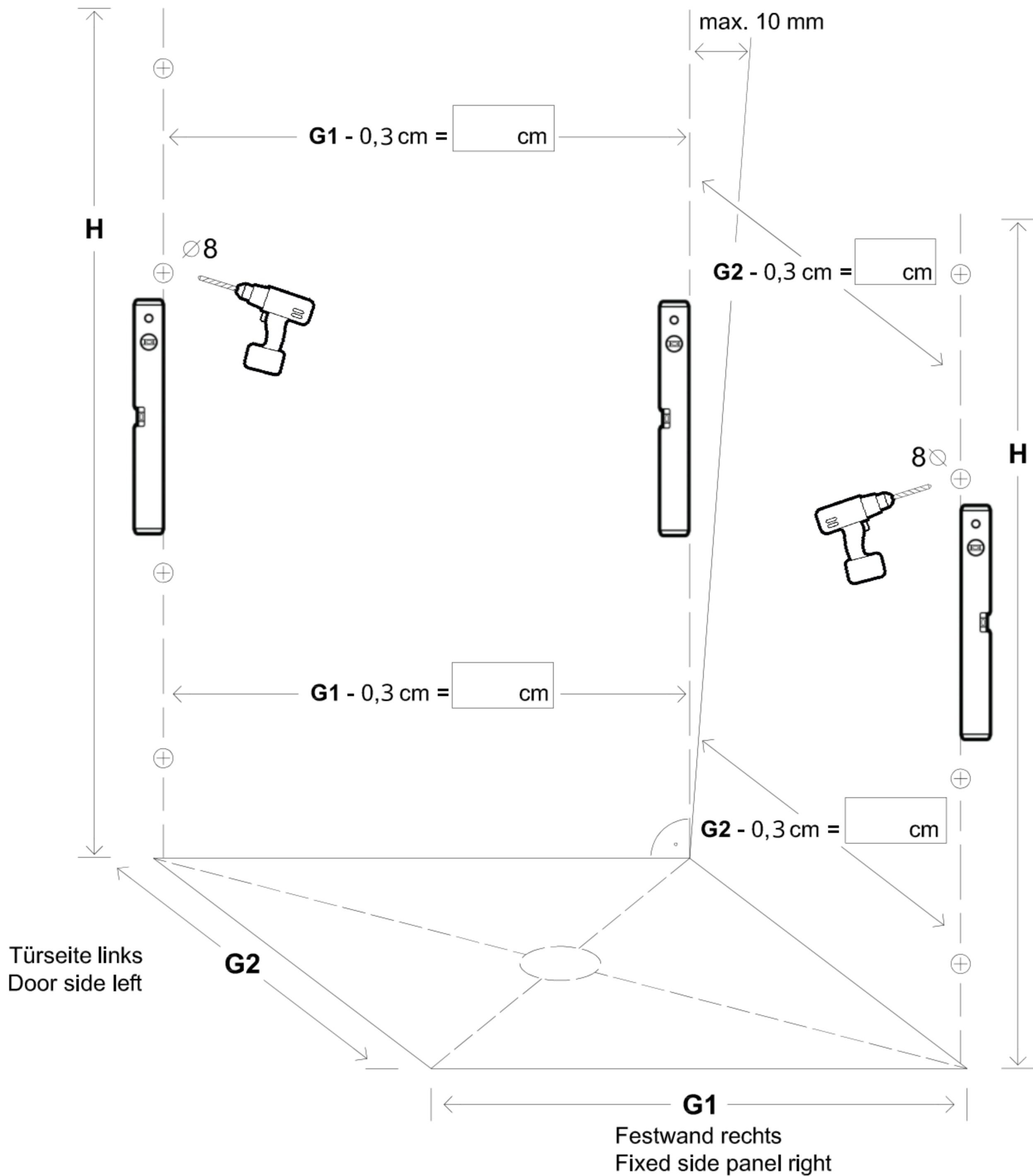

Benutzen Sie das Wandprofil in Glashöhe zum anzeichnen der Bohrlöcher.
Use the wall profile in height of glass to mark the drill holes.

Diese Maße finden Sie in ihrem Auftrag:
You find this measures in your order:

H = Glas - Höhe
Glass height

G1, G2 = Glasaußenkante (unterer Wert des Verstellbereichs)
Outer edge of the glass (lower value of adjustment range)

Die Zeichnungen sind **nicht** Maßstabsgetreu.
The drawings are **not** to scale.

Vormontage von Dichtprofilen und Beschlägen Pre-assembly of gaskets and fittings.

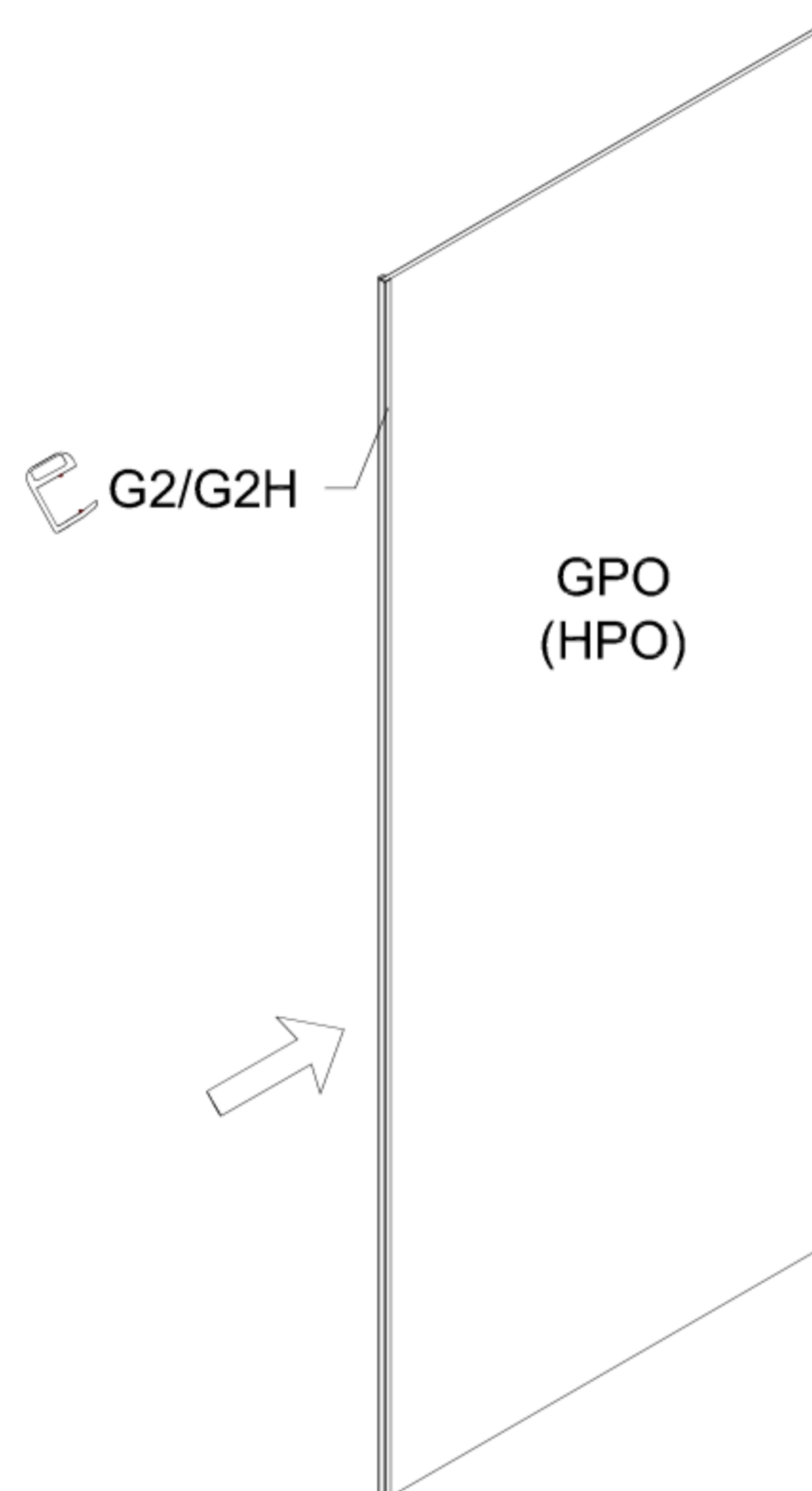
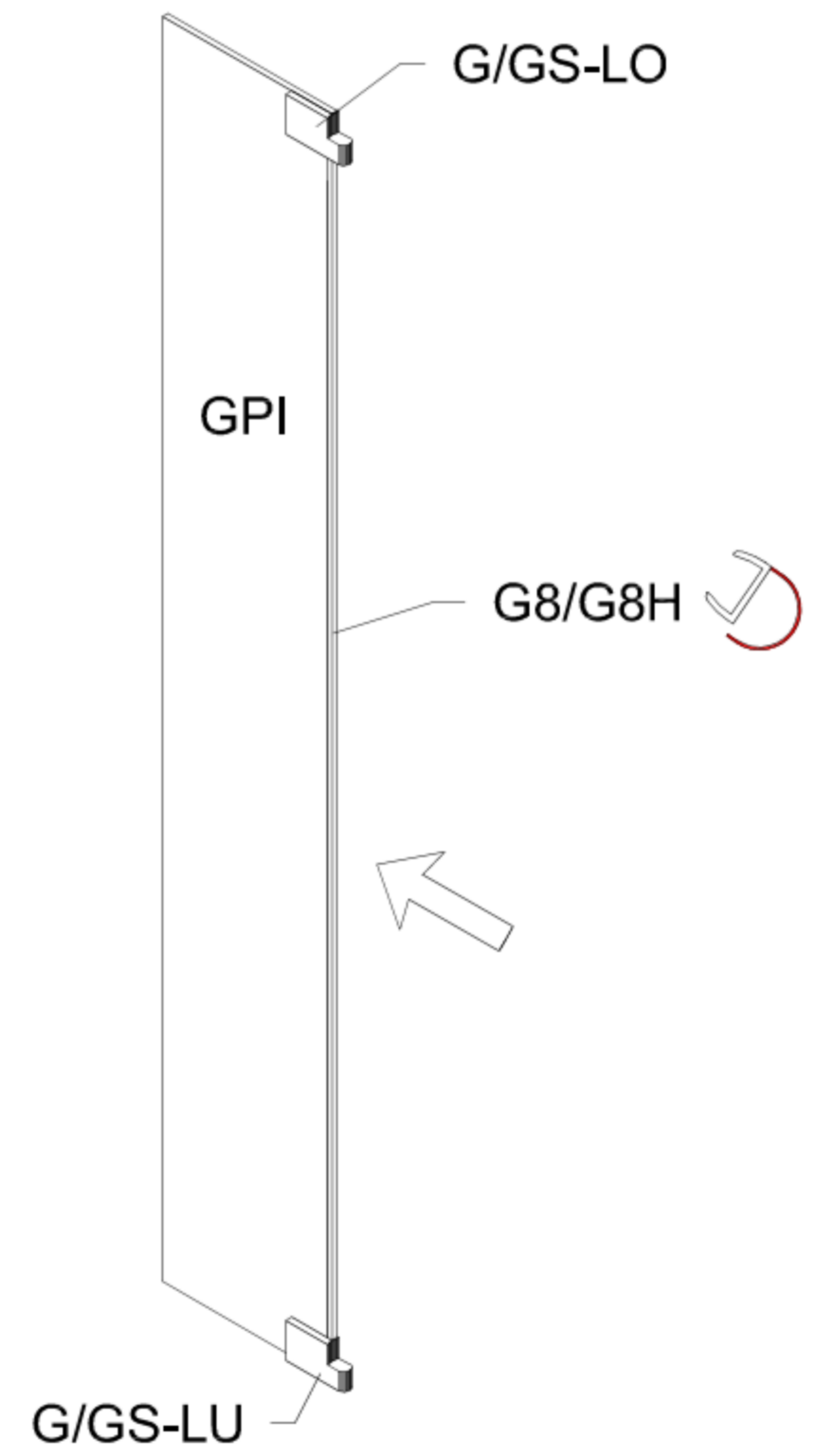
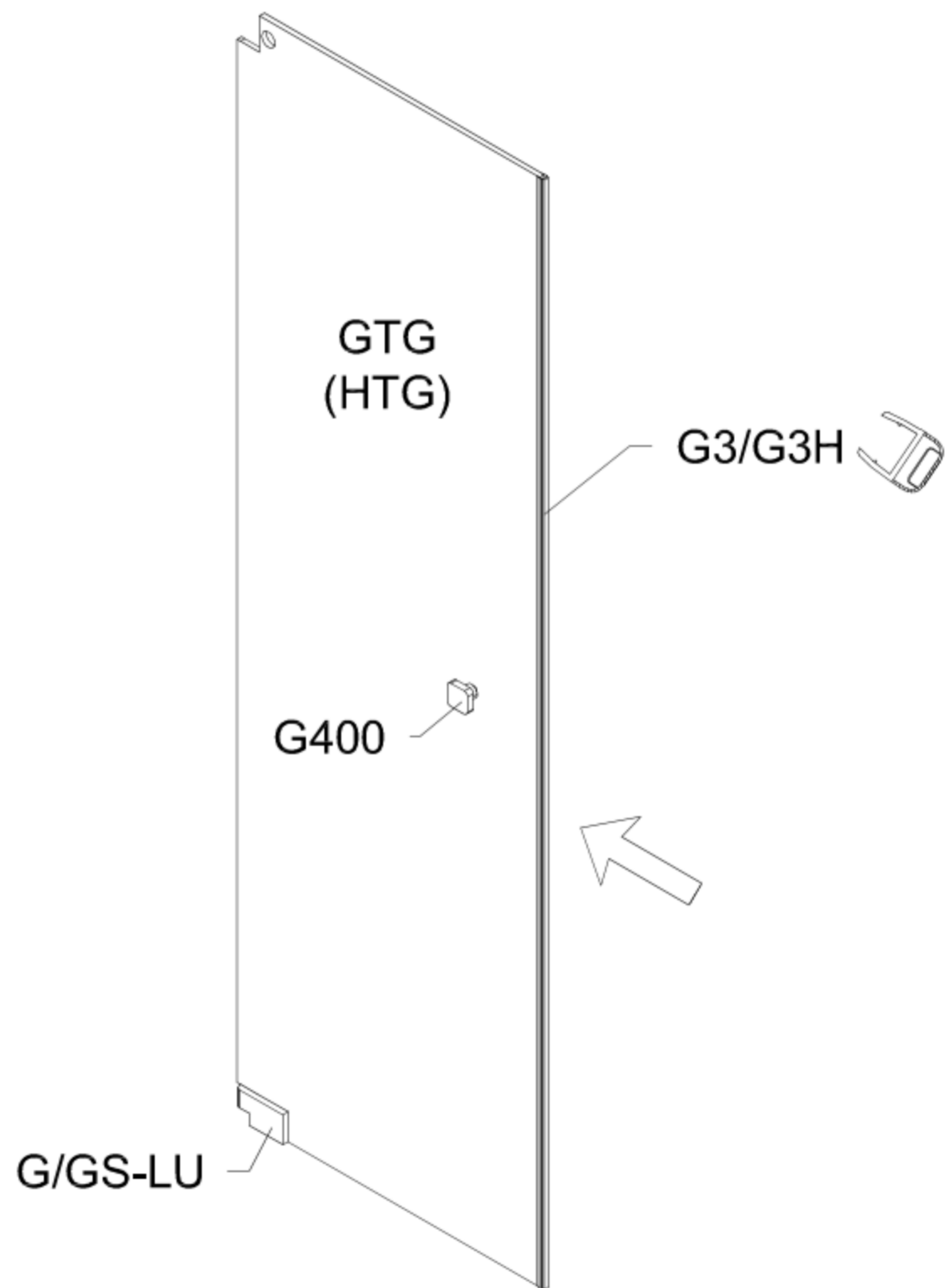

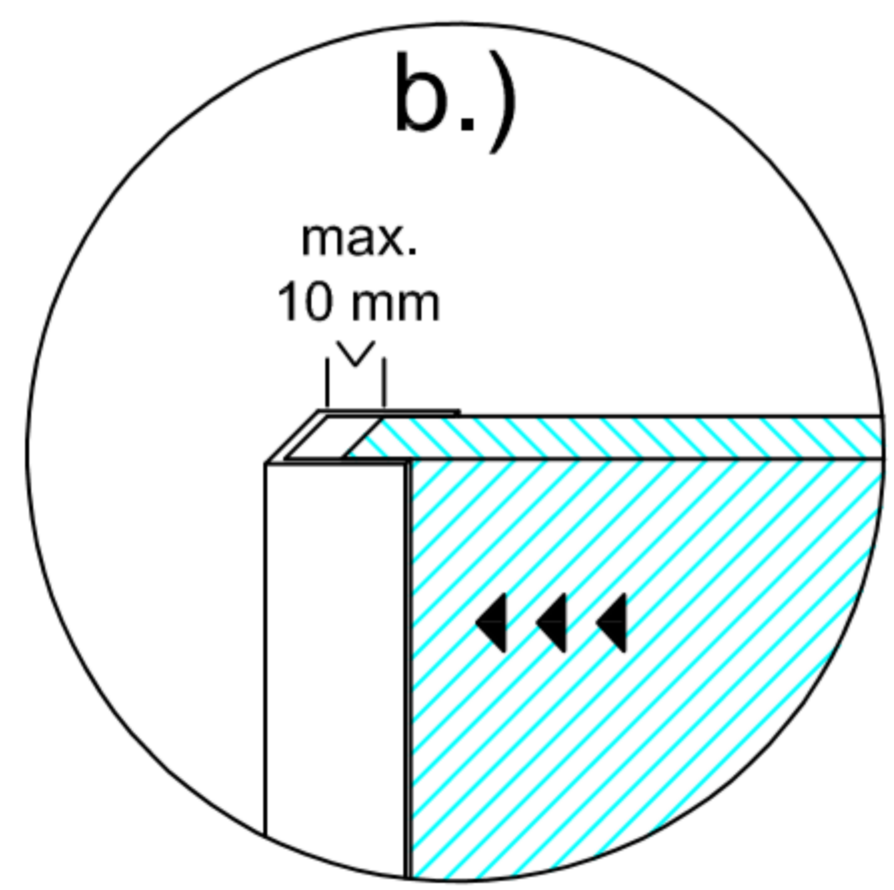
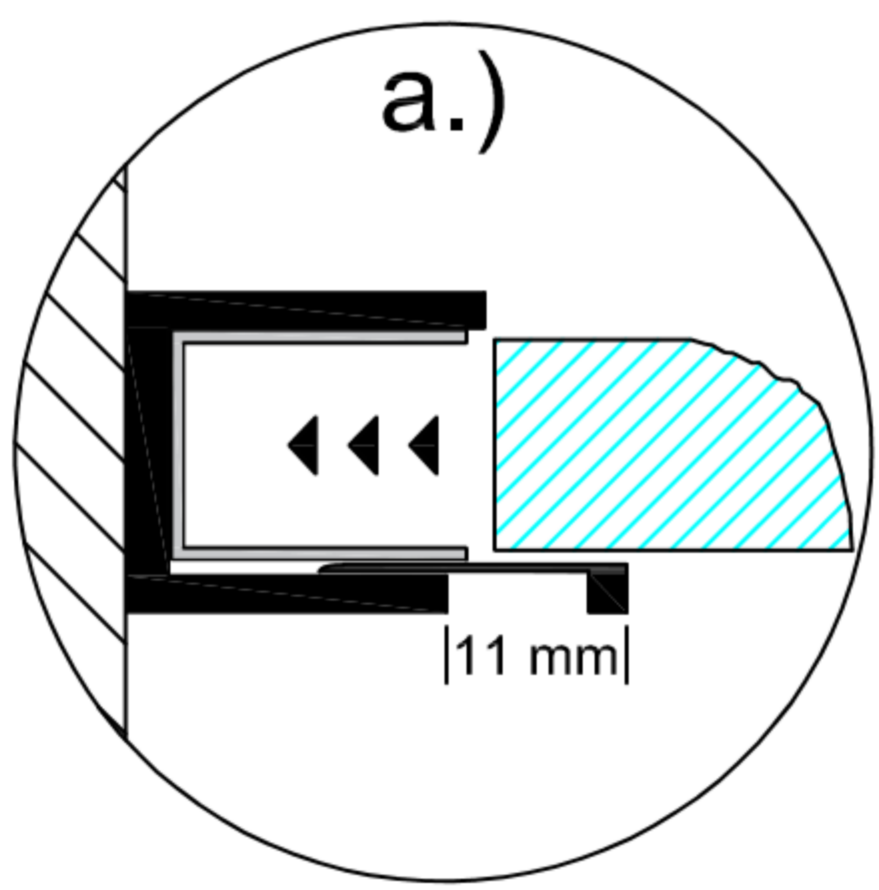
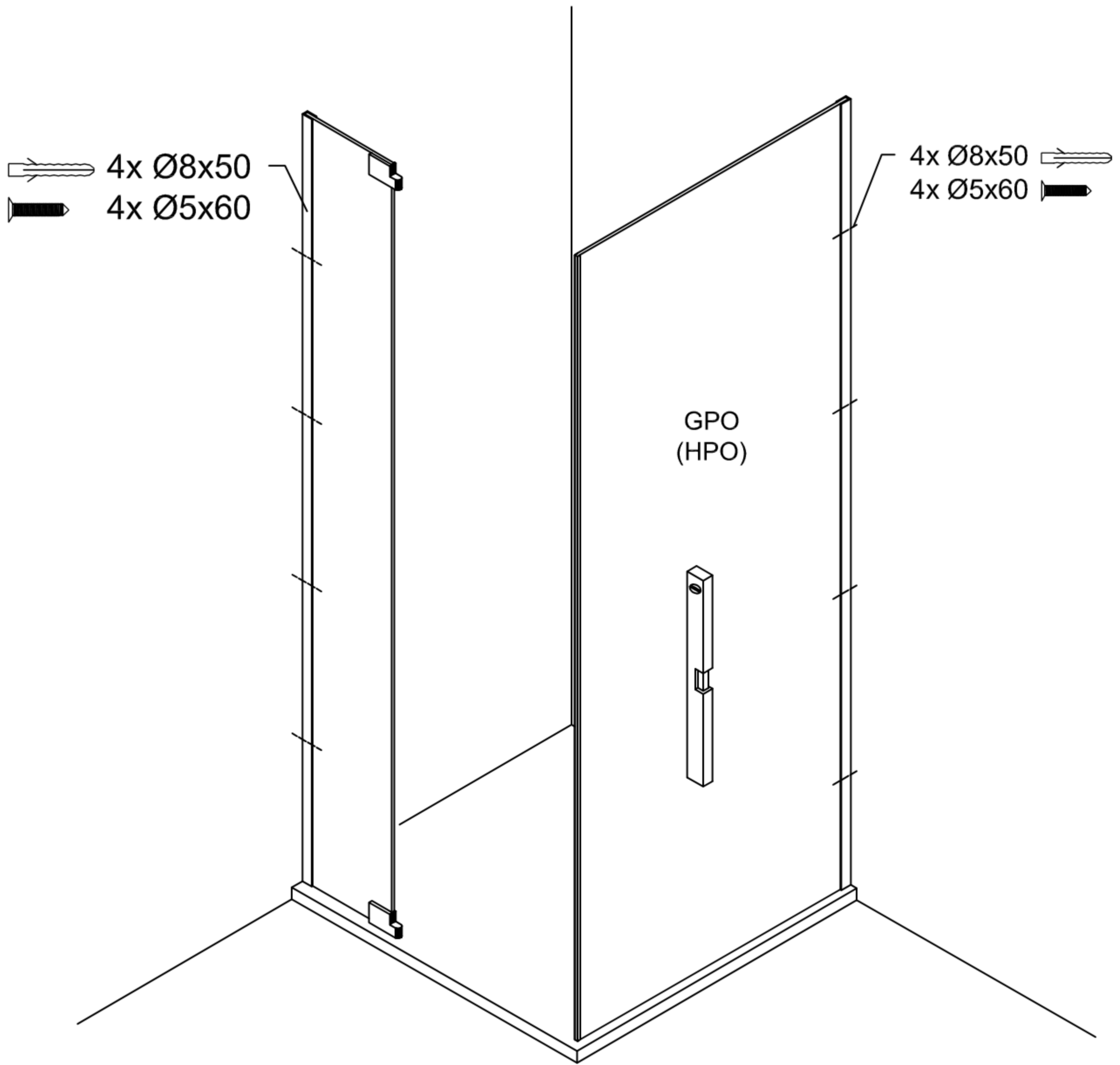

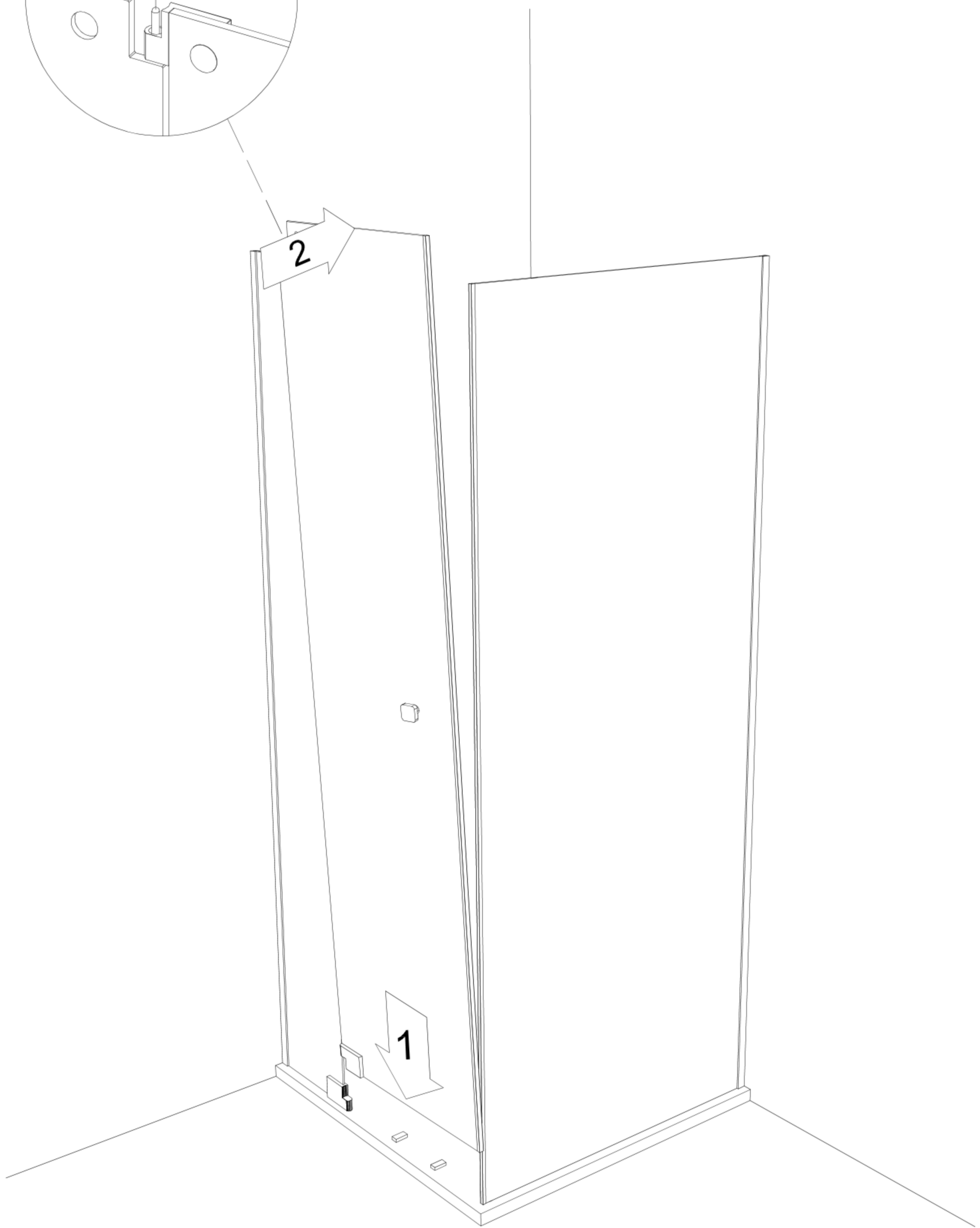
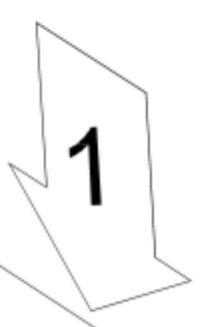
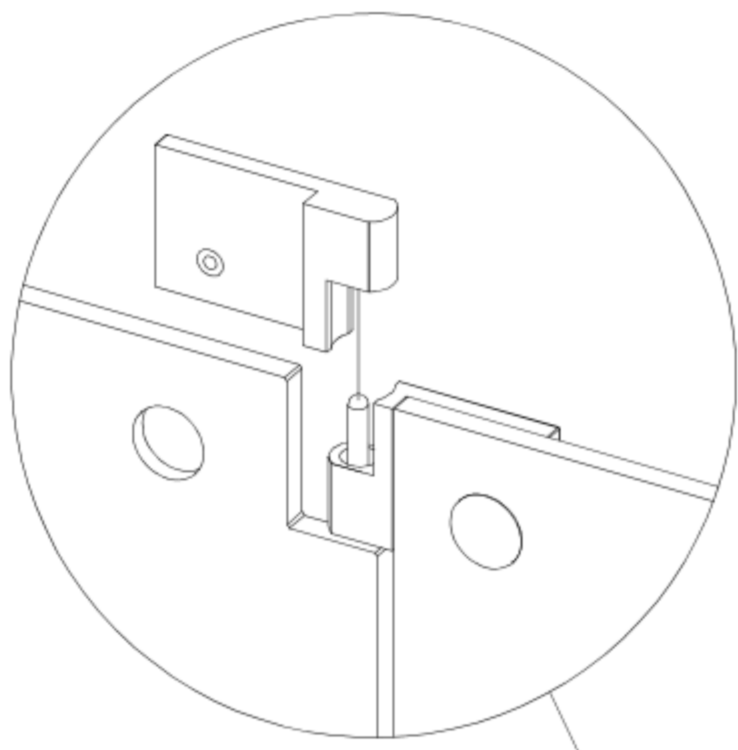

Wieder öffnen:
Open again:
Per riaprire:
Ouvrir à nouveau:

