

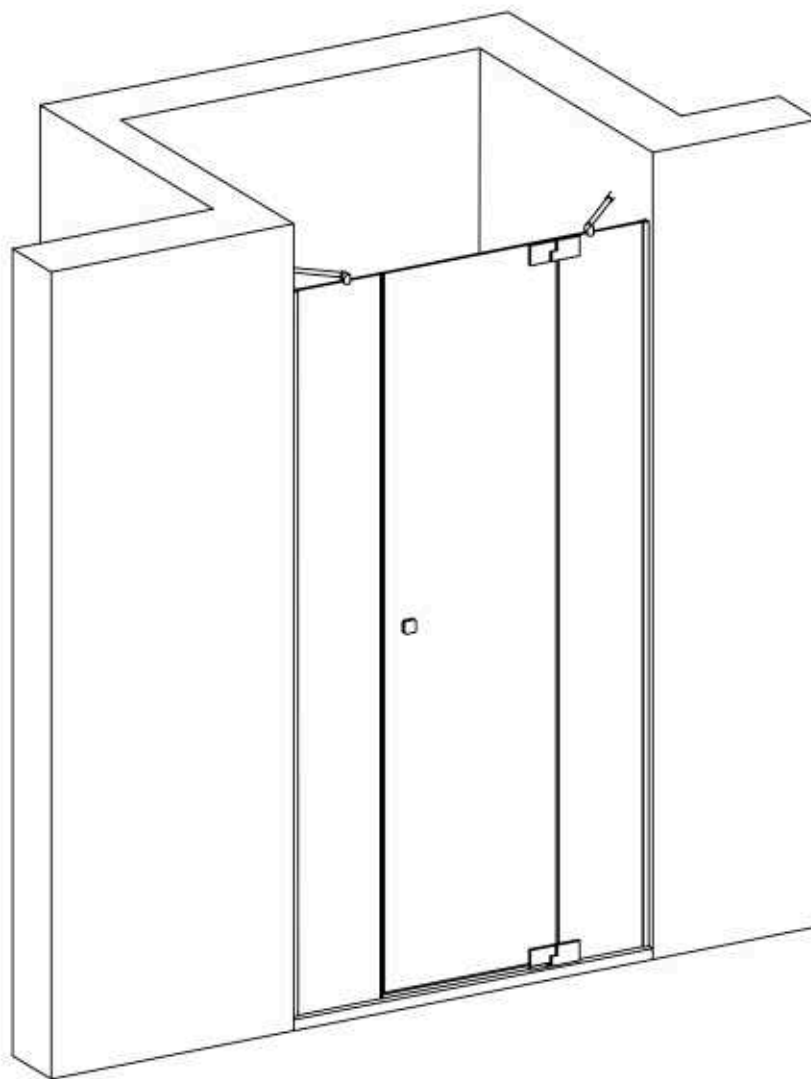

















# Modell PG2N, PH2N, PGXN, PHXN, PMG2N - ab 100

Montageanleitung  
Installation Manual



Duschabtrennung für Nische  
Shower enclosure for niche  
Rechts / Right

1 x G/GS-RO		2 x G3/G3H		4 x G100		8 x 5x60		2 x 
1 x G/GS-RU		1 x G8/G8H		4 x G300		8 x 8x50		1 x 
2 x P/WKP		1 x G10		1 x G400		4 x M6x12		1 x 
		8 x d		4 x C2		2 x G/SUP40		

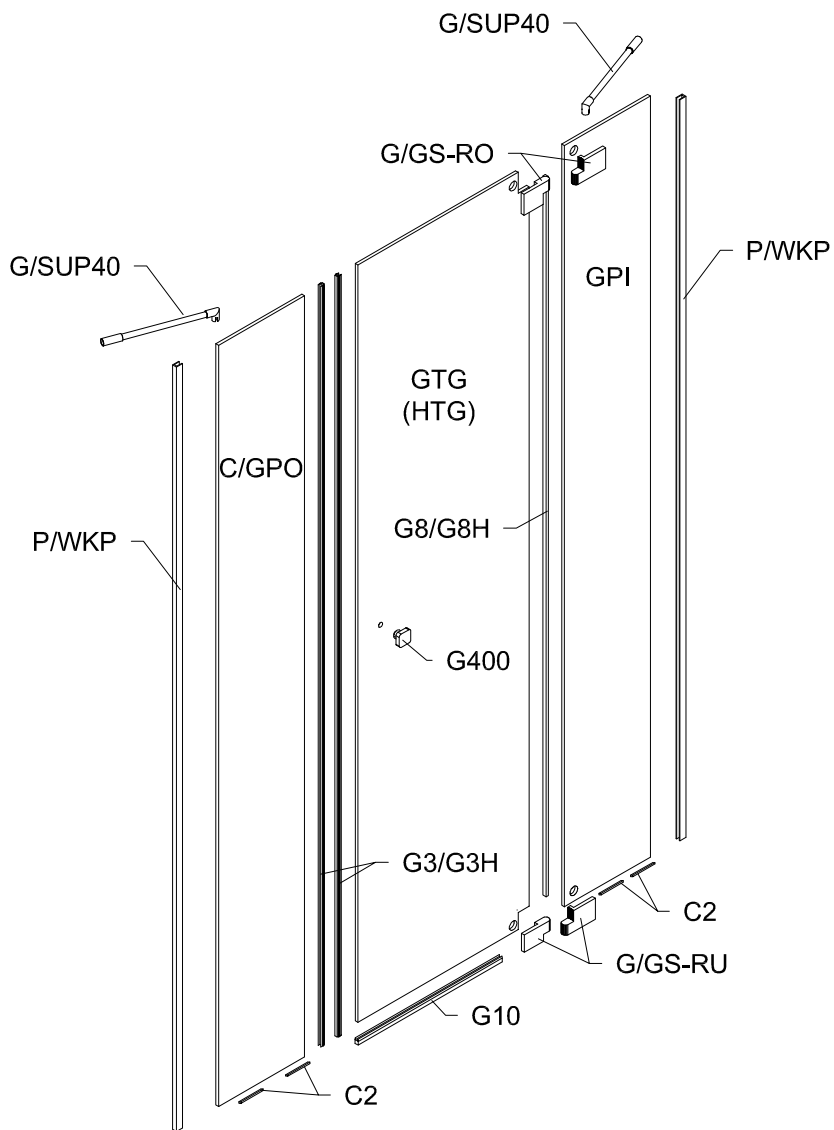

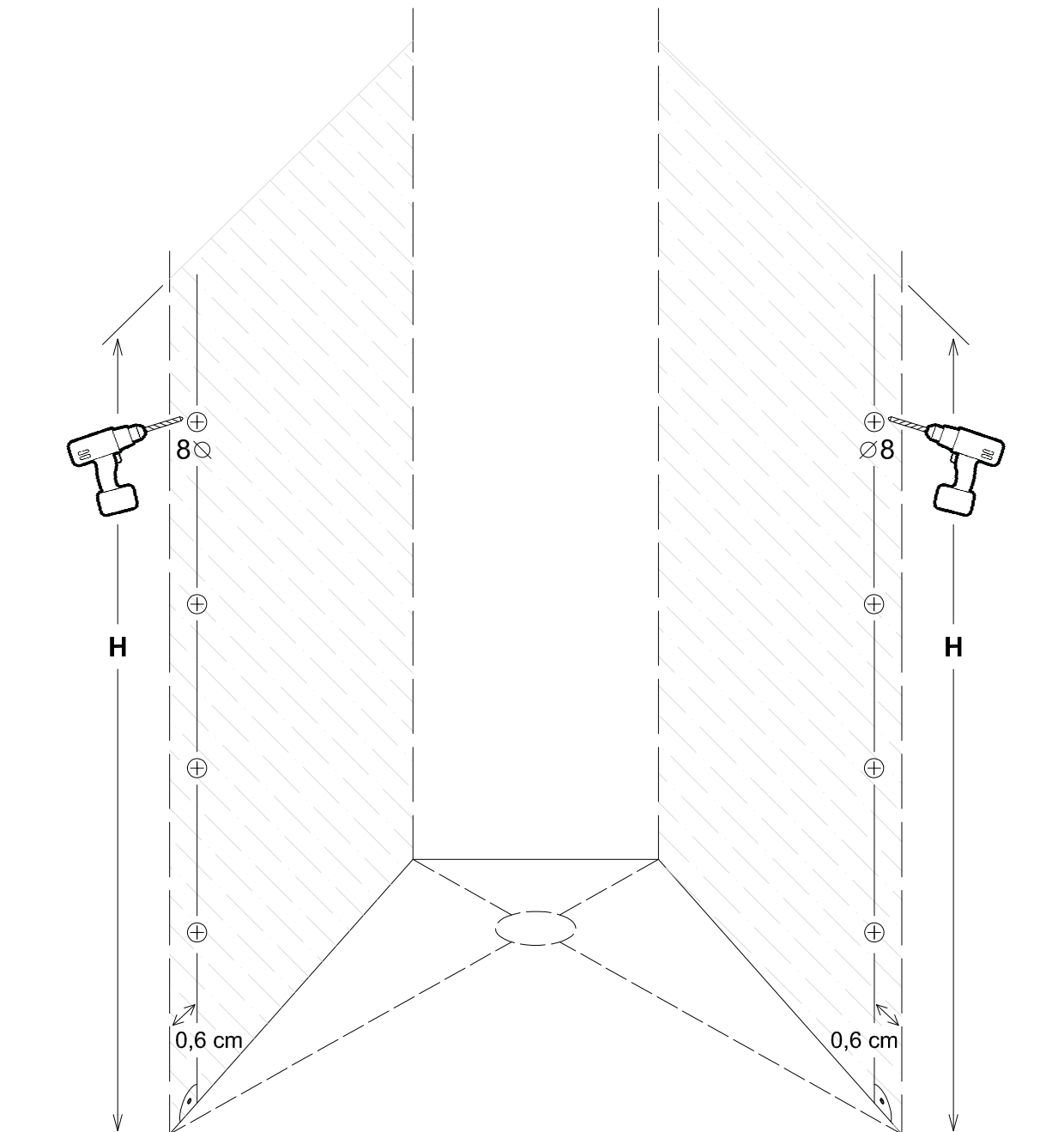

Benutzen Sie das Wandprofil in Glashöhe zum anzeichnen der Bohrlöcher.  
Use the wall profile in height of glass to mark the drill holes.

Diese Maße finden Sie in ihrem Auftrag:  
You find this measures in your order:

- H** = Glas - Höhe  
Glass height
- G1, G2** = Glasaußenkante (unterer Wert des Verstellbereichs)  
Outer edge of the glass (lower value of adjustment range)

Die Zeichnungen sind **nicht** Maßstabsgetreu.  
The drawings are **not** to scale.

## Vormontage von Dichtprofilen und Beschlägen Pre-assembly of gaskets and fittings.

