

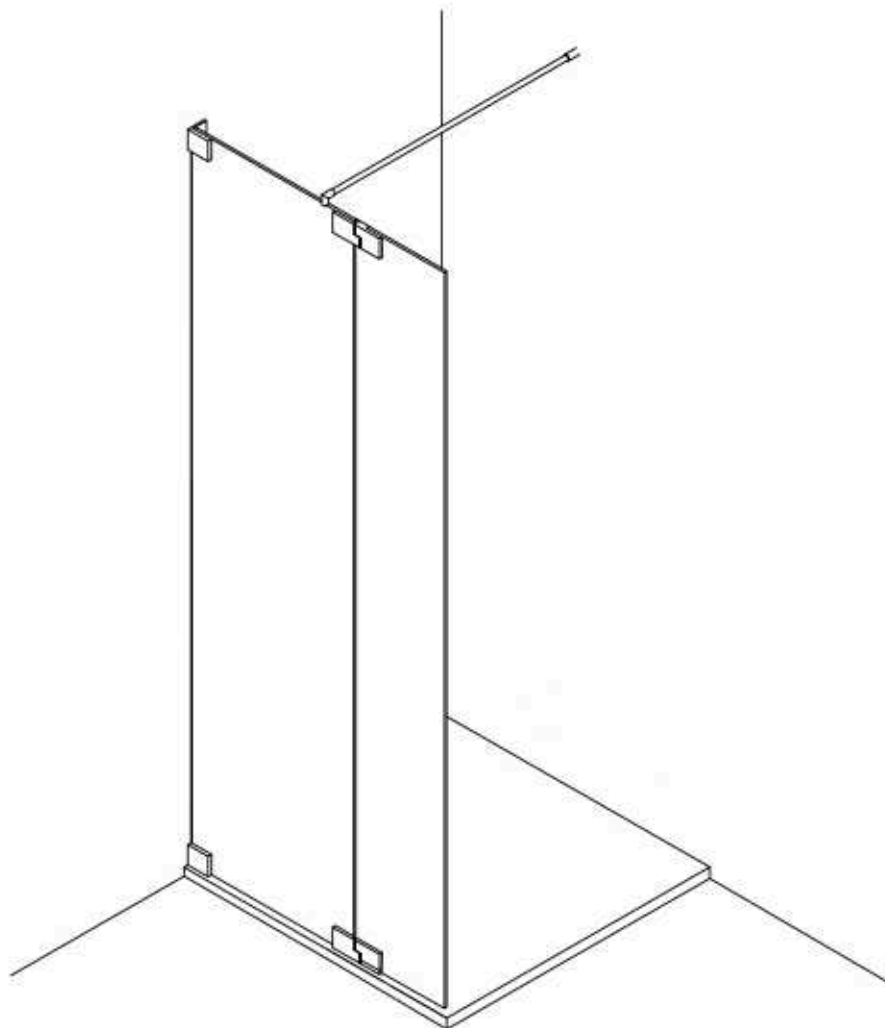

















Modell GW2, HW2, MGW2

Montageanleitung
Installation Manual



Eck-Dusche mit Festwand
Corner shower enclosure with fixed side panel
Links / Left

- | | | | | | | | |
|----------------|---|--------------|---|----------|---|---|---|
| 1 x G/FX-LU/RO |  | 1 x G13/G13H |  | 6 x G100 |  | 4 x  | 1 x  |
| 1 x G/FX-LO/RU |  | 1 x G8/G8H |  | 6 x G300 |  | 4 x  | 1 x  |
| 1 x G/GS-LO |  | | | 2 x G301 |  | 6 x  | 4 x  |
| 1 x G/GS-LU |  | 1 x G/SUL120 |  | 2 x G302 |  | 4 x C2 |  |

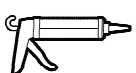
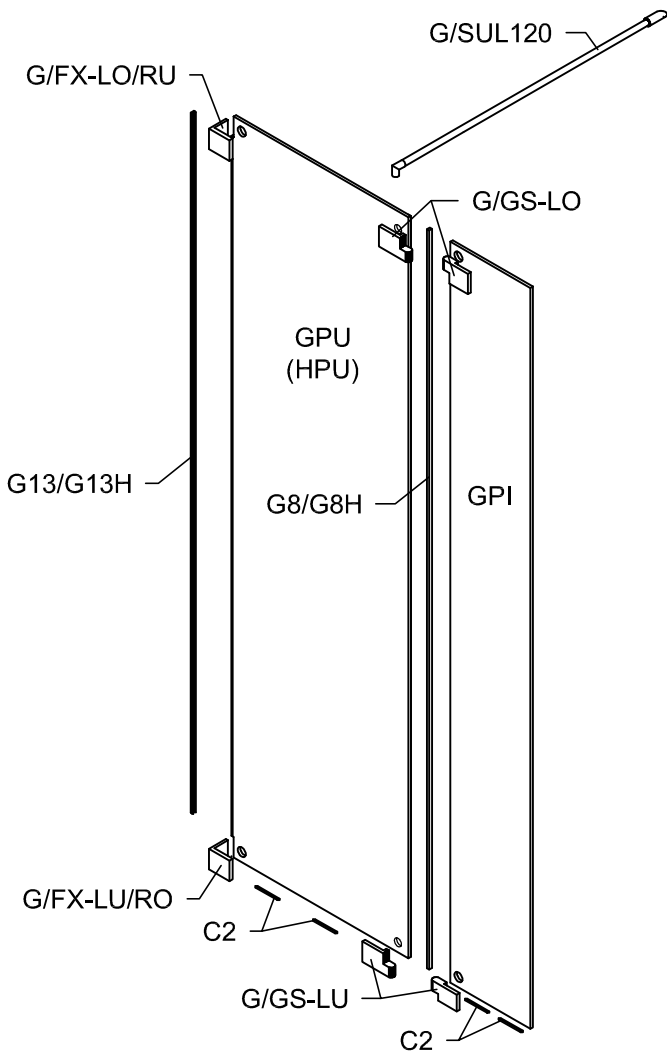

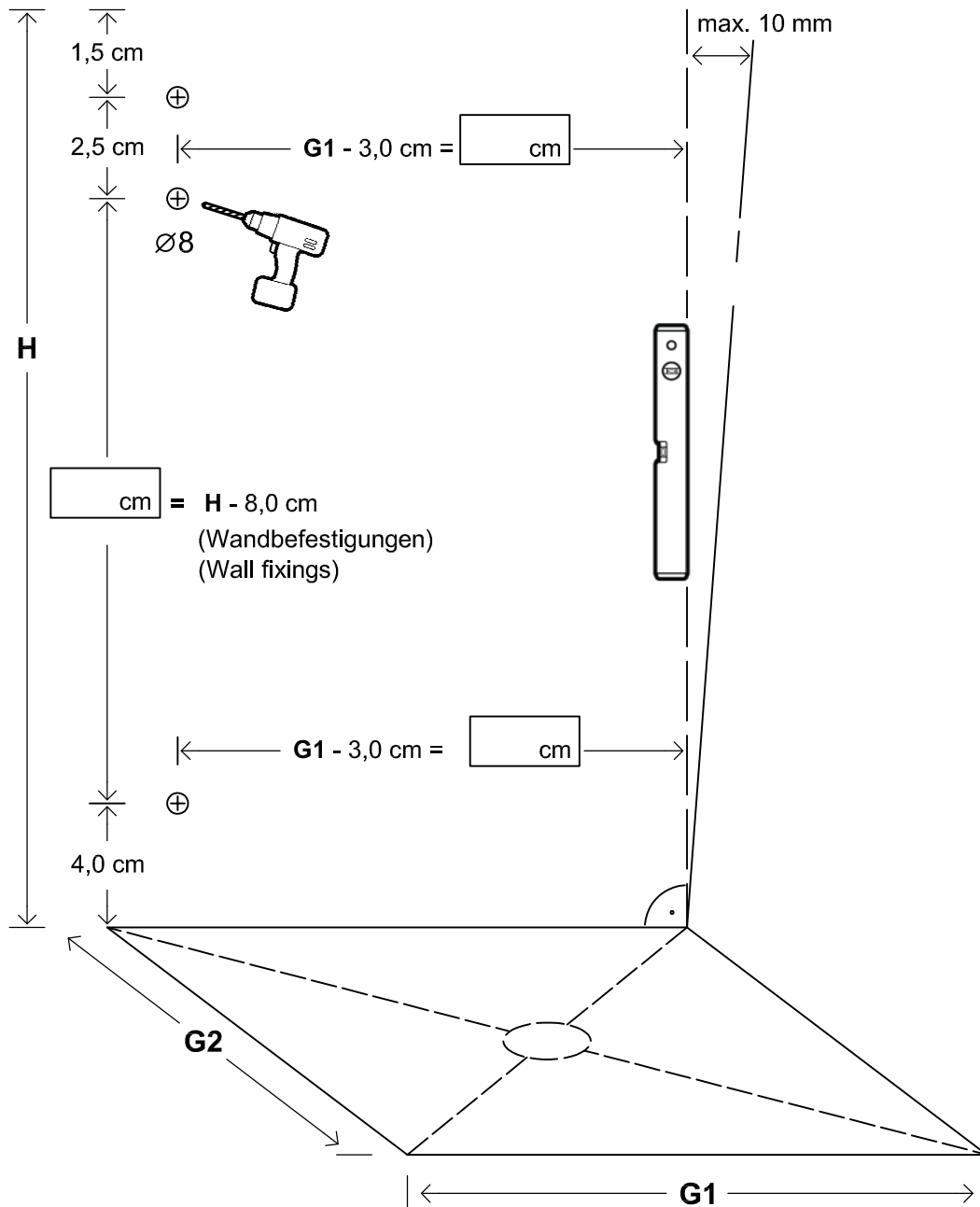

Diese Maße finden Sie in ihrem Auftrag:
You find this measures in your order:

H = Glas - Höhe
Glass height

G1, G2 = Glasaußenkante (unterer Wert des Verstellbereichs)
Outer edge of the glass (lower value of adjustment range)

Die Zeichnungen sind **nicht** Maßstabsgetreu.
The drawings are **not** to scale.

Vormontage von Dichtprofilen und Beschlägen Pre-assembly of gaskets and fittings.

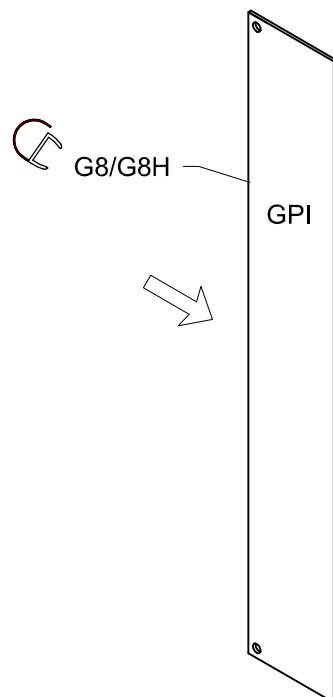
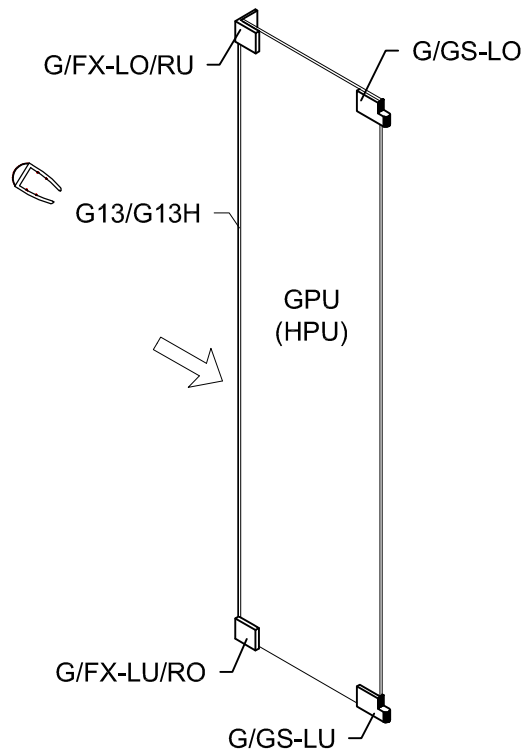

Bei gerader Wand kann auf das Kompensationsprofil G13/G13H verzichtet werden und der senkrechte Wandanschluss wird dann absilikoniert (Abstand Wand / Glas min. 3 mm).

A straight wall does not need the compensation gasket G13/G13H. In this case apply silicone caulking to the vertical connection (distance wall / glass min. 3 mm).

2x Ø8x50
2x Ø5x60

1x Ø8x50
1x Ø5x60

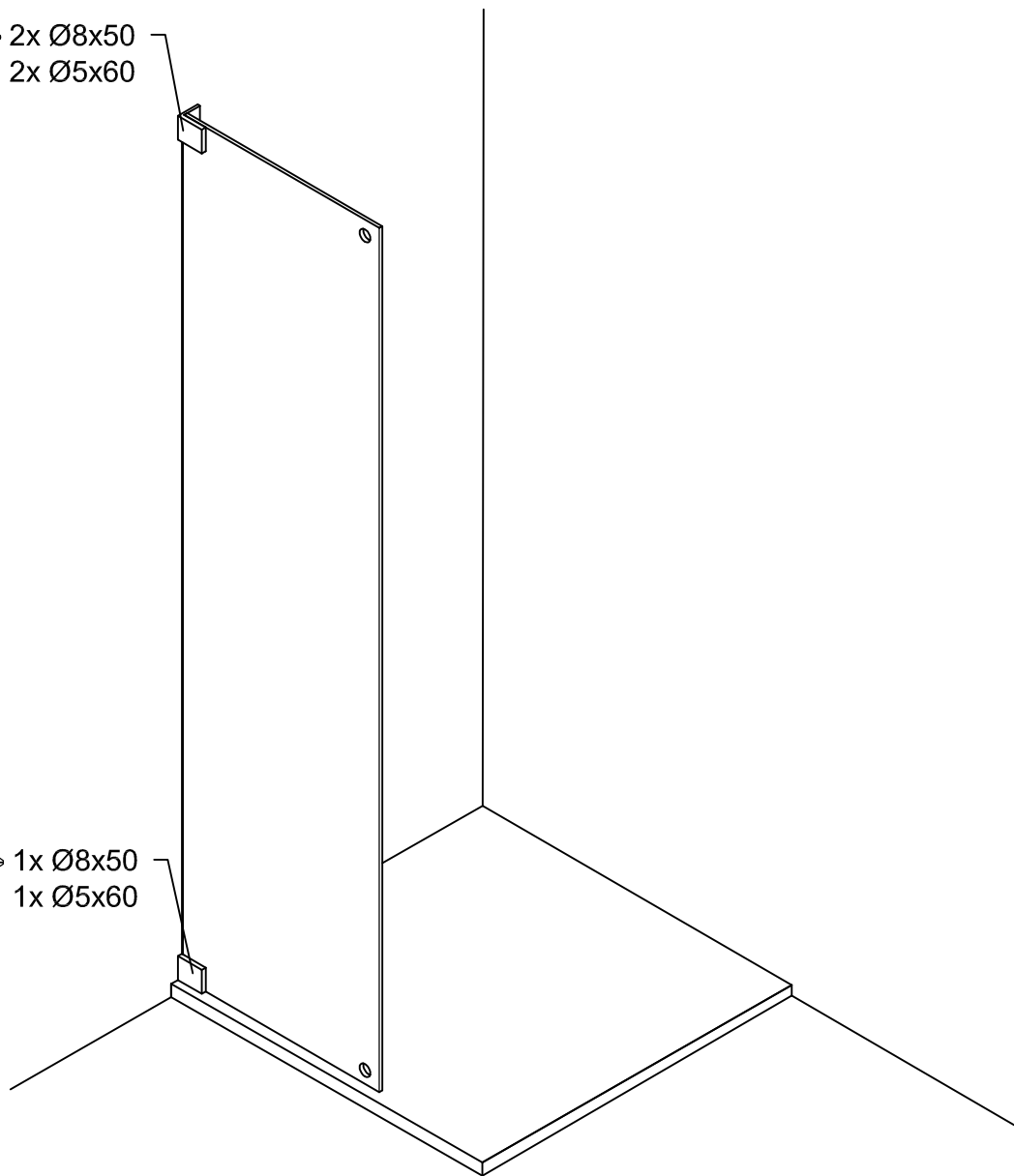

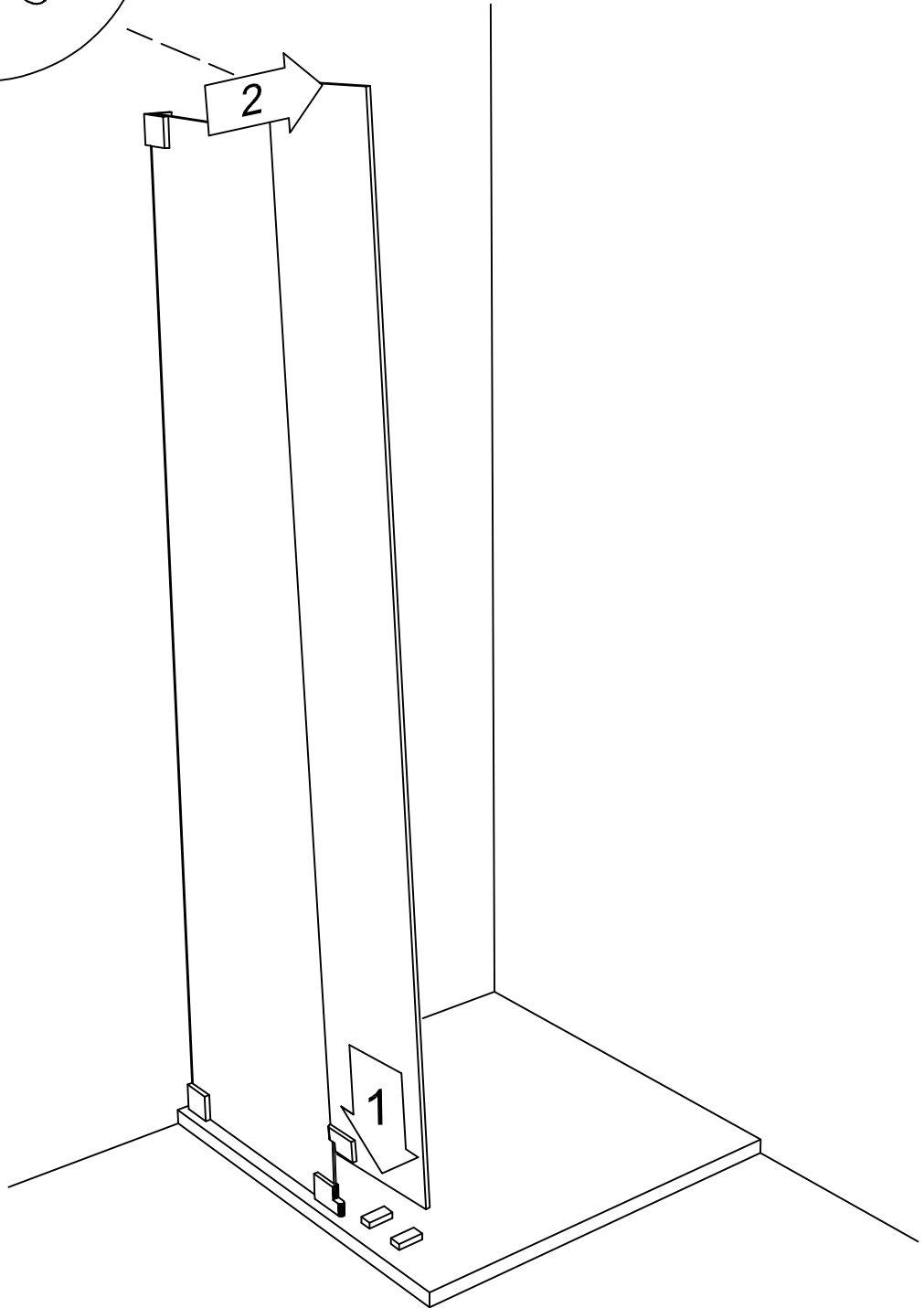
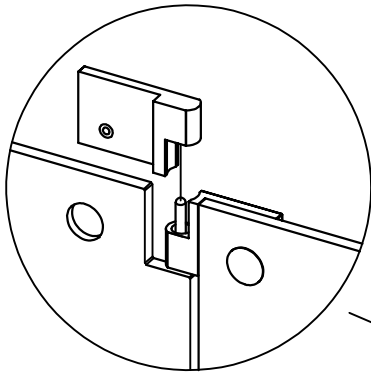

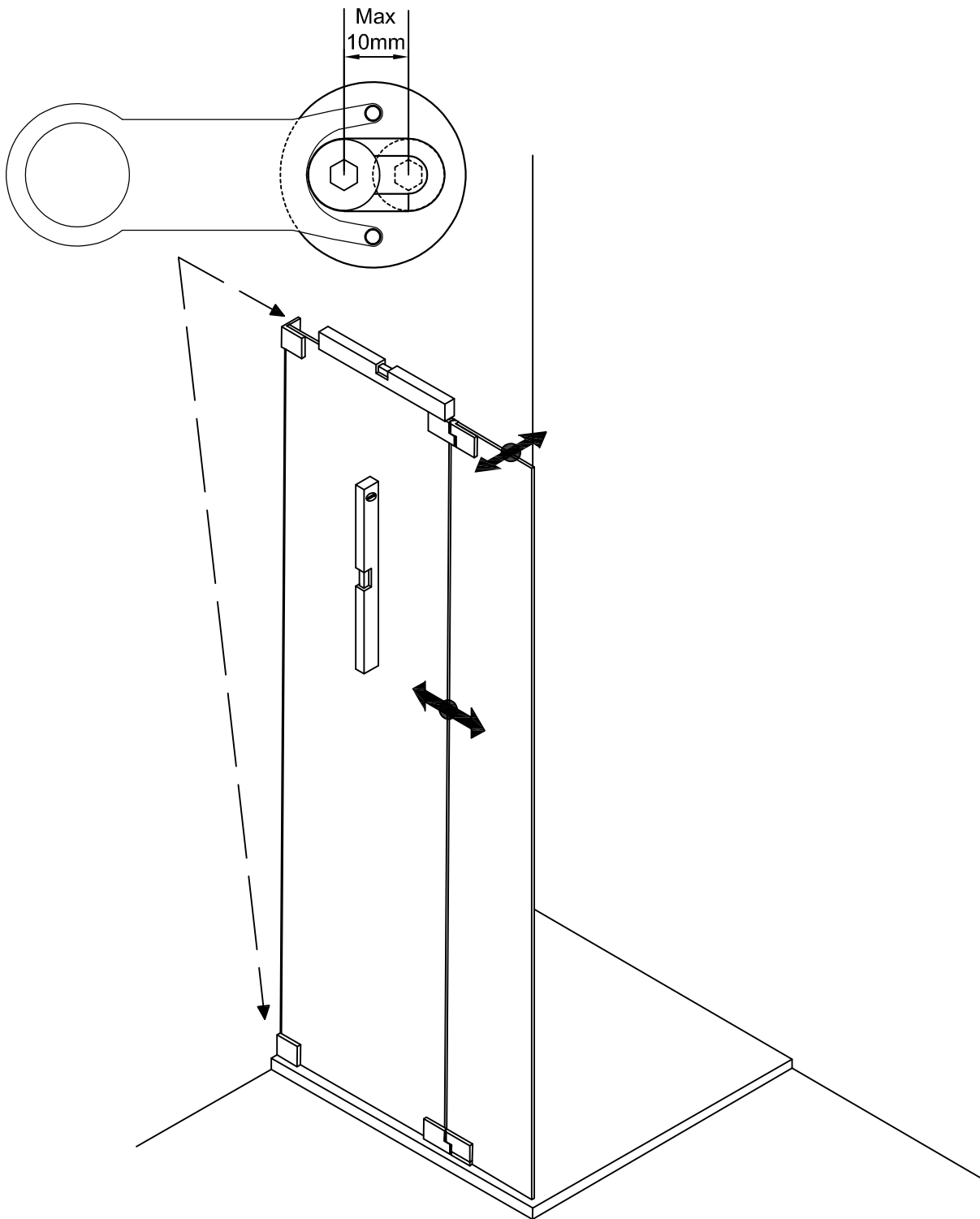

Richten Sie das Glas-Festteil senkrecht aus und fixieren sie die Inbus-Schrauben in den Langlöchern der Glasbefestigungen. Mit dem Montage-Schlüssel können die Glasbefestigungen dabei waagrecht gehalten werden. Schieben Sie dann das Kompensationsprofil (G13 / G13H) auf dem Glas mit Druck an die Wand, um Schrägen auszugleichen. Bei gerader Wand kann auf das Kompensationsprofil verzichtet werden und der senkrechte Wandanschluss absilikoniert werden (Abstand Wand / Glas min. 3 mm).

Set up the fixed glass part vertically and fix the Inbus screws in the slotted holes of the glass fixings. By using the installation key the glass fixings can be kept horizontally. Slide the compensation gasket (G13 / G13H) with force on the glass against the wall to even out possible slopes. A straight wall does not need the compensation gasket. In this case apply silicone caulking to the vertical connection (distance wall / glass min. 3 mm).

