

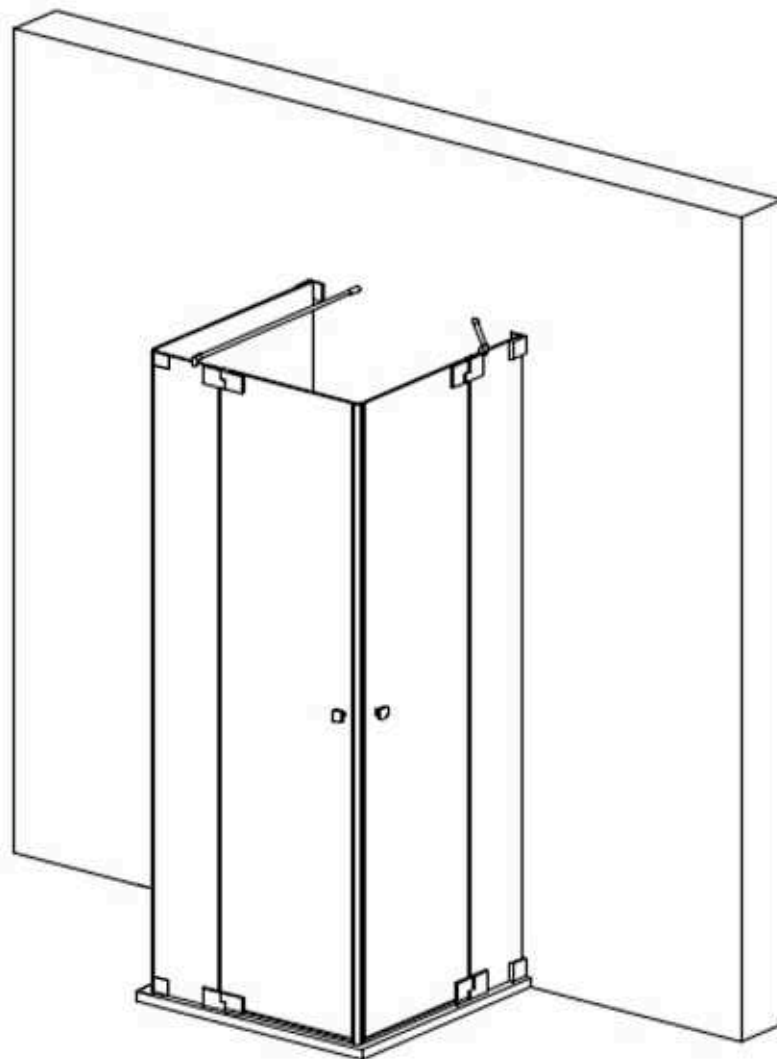

























Modell GU2E, HU2E, MGU2E

Montageanleitung
Installation Manual



3-Seiten U-Duschkabine
U-shaped shower enclosure
Rechts / Right

1 x G/GS-RO		1 x G5/G5H		16 x G100		8 x 5x60		1 x 
1 x G/GS-RU		2 x G8/G8H		16 x G300		8 x 8x50		1 x 
1 x G/GS-LO		1 x G9/G9H		4 x G301		16 x M6x12		6 x C2 
1 x G/GS-LU		2 x G10		4 x G302		4 x 		
2 x G/FX-LU/RO		2 x G13/G13H		2 x G400		1 x G/SUP40		
2 x G/FX-LO/RU		2 x G/EL				1 x G/SUL120		

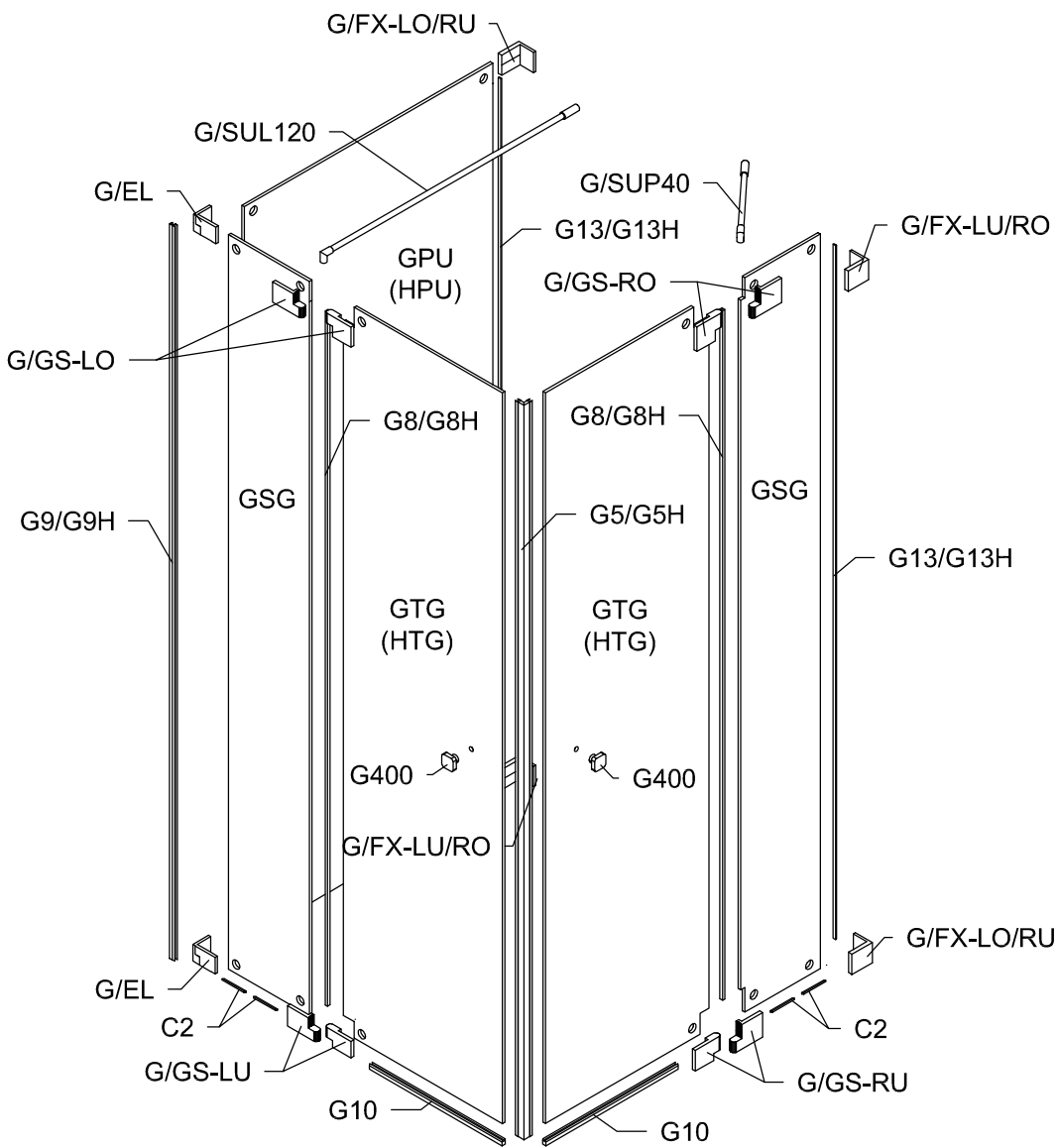

Vormontage von Dichtprofilen und Beschlügen Pre-assembly of gaskets and fittings.

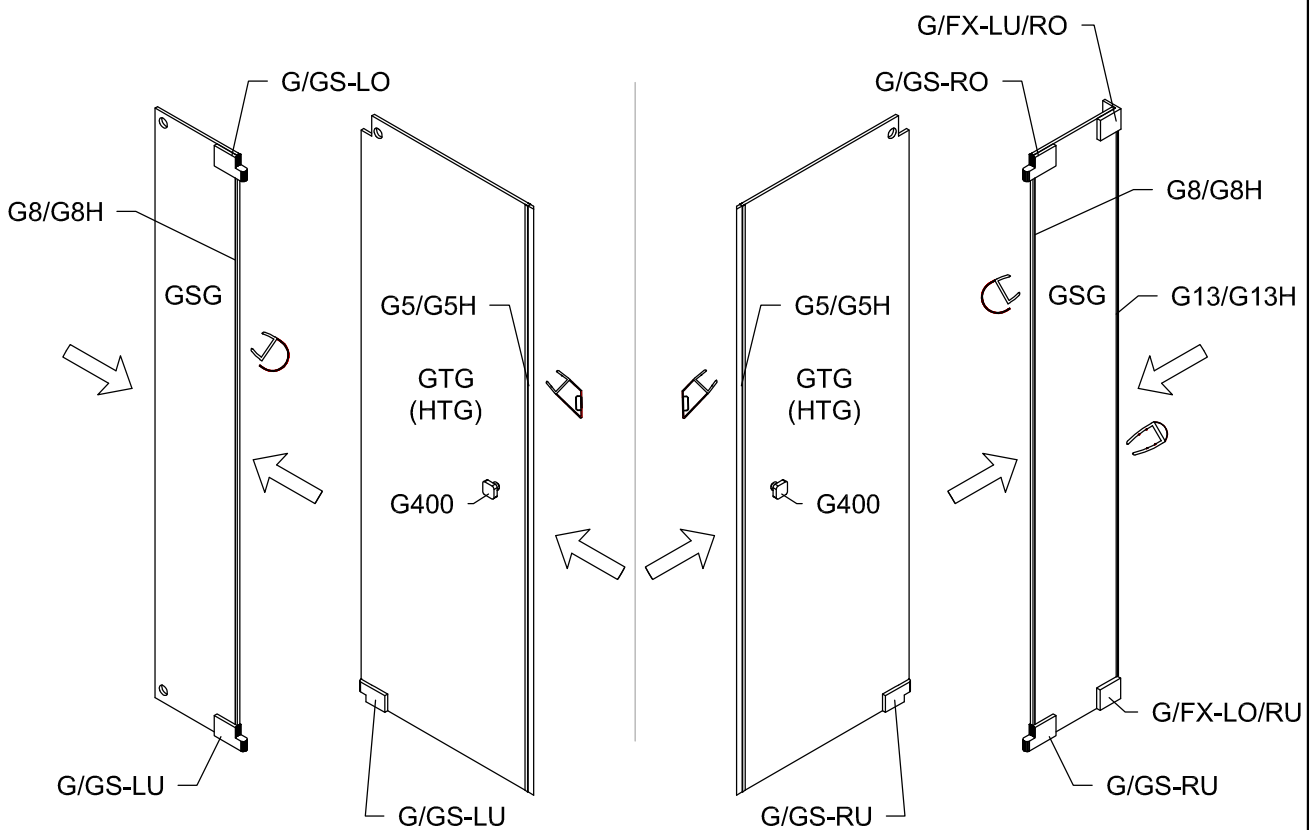
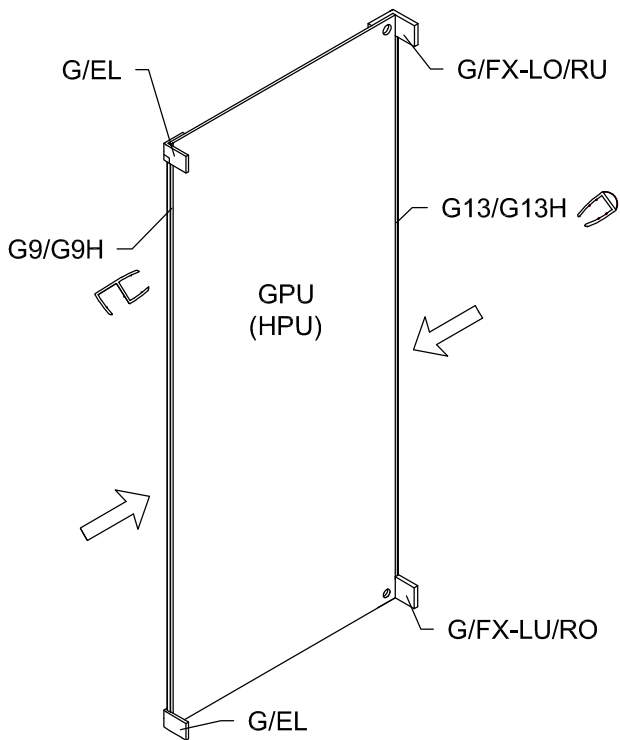

Bei gerader Wand kann auf das Kompensationsprofil G13/G13H verzichtet werden und der senkrechte Wandanschluss wird dann absilikoniert (Abstand Wand / Glas min. 3 mm).

A straight wall does not need the compensation gasket G13/G13H. In this case apply silicone caulking to the vertical connection (distance wall / glass min. 3 mm).

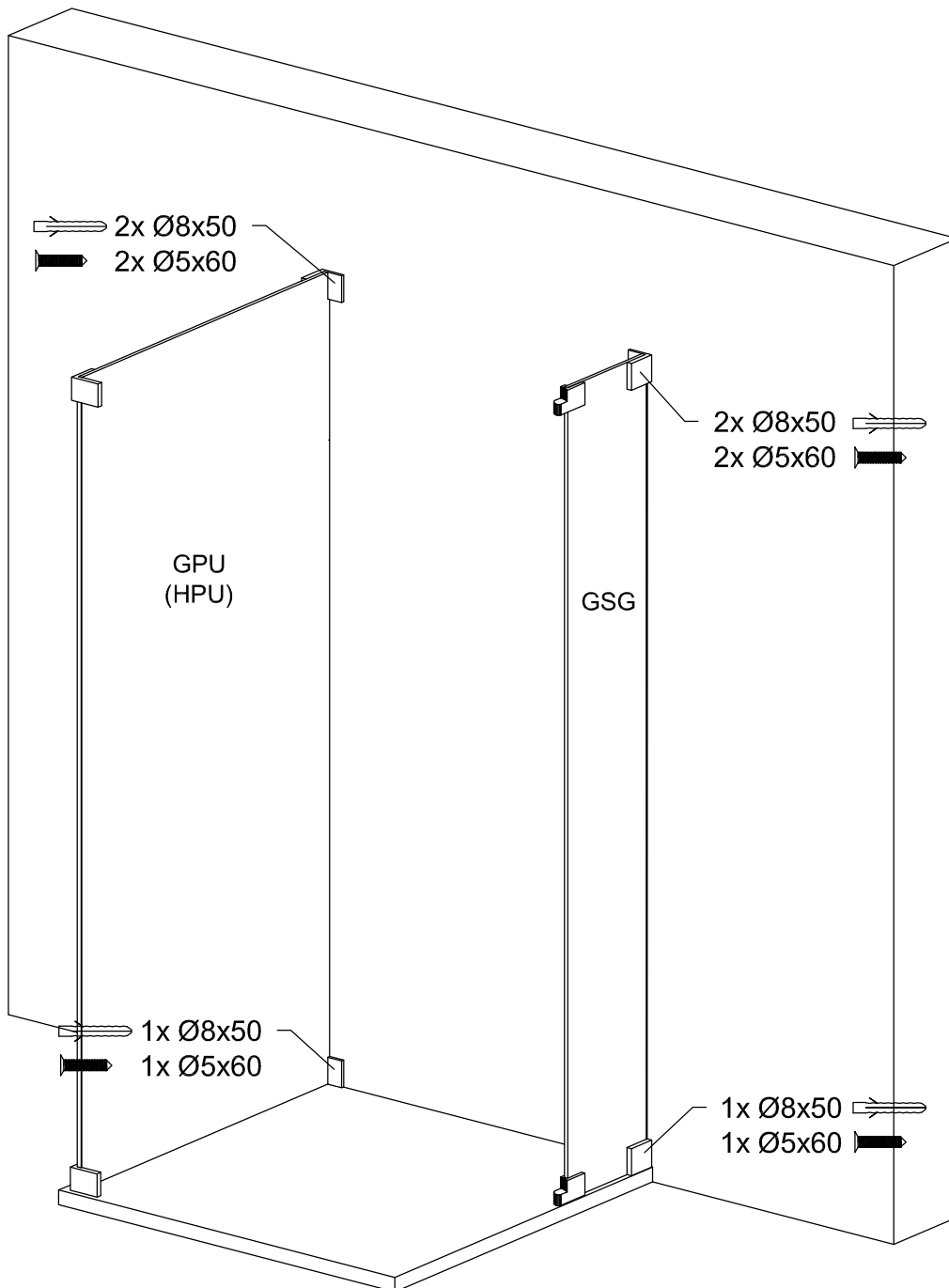

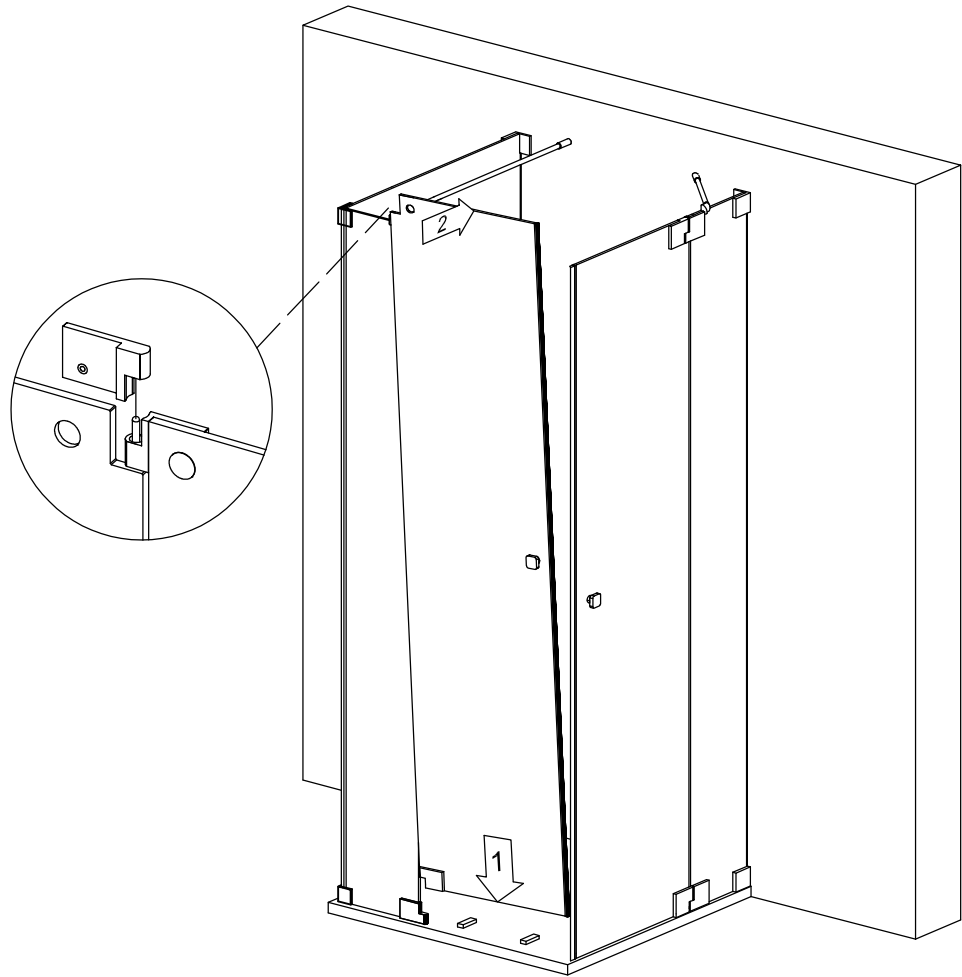
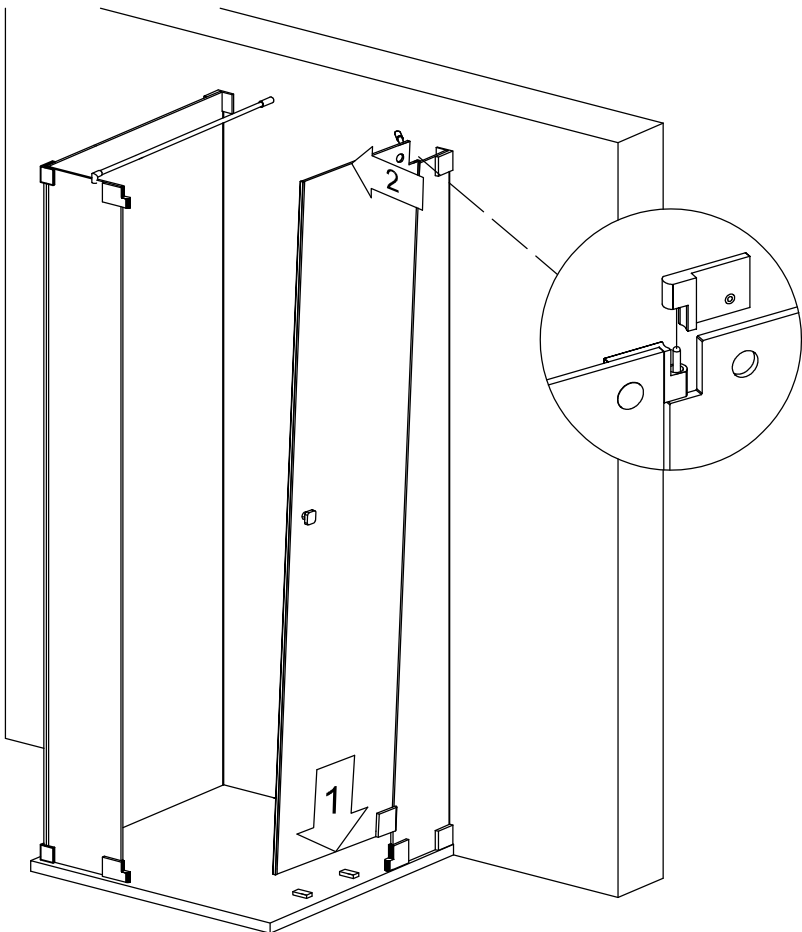

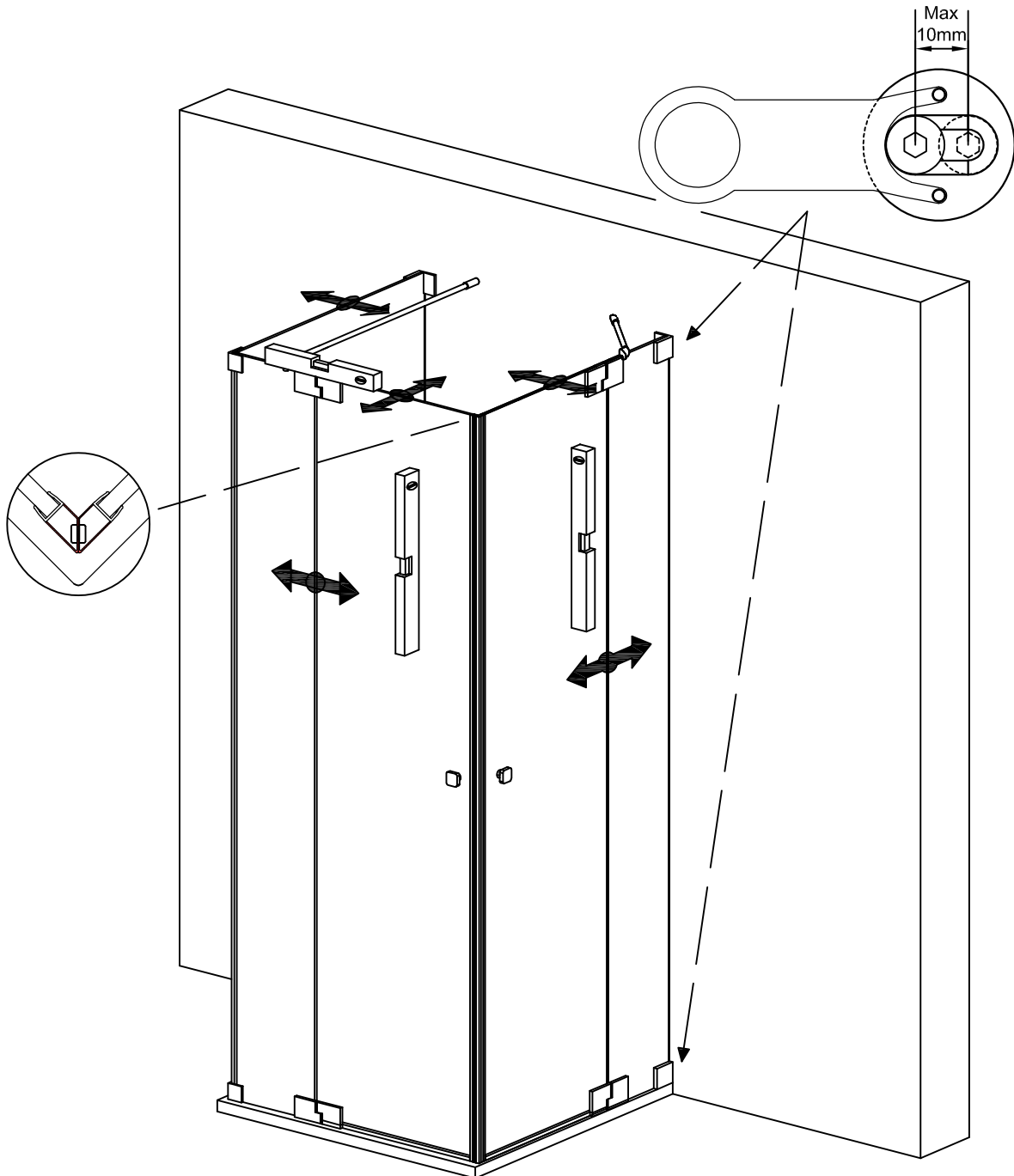

Richten Sie das Glas-Festteil senkrecht aus und fixieren sie die Inbus-Schrauben in den Langlöchern der Glasbefestigungen. Mit dem Montage-Schlüssel können die Glasbefestigungen dabei waagrecht gehalten werden. Schieben Sie dann das Kompensationsprofil (G13 / G13H) auf dem Glas mit Druck an die Wand, um Schrägen auszugleichen. Bei gerader Wand kann auf das Kompensationsprofil verzichtet werden und der senkrechte Wandanschluss absilikontiert werden (Abstand Wand / Glas min. 3 mm).

Set up the fixed glass part vertically and fix the Inbus screws in the slotted holes of the glass fixings. By using the installation key the glass fixings can be kept horizontally. Slide the compensation gasket (G13 / G13H) with force on the glass against the wall to even out possible slopes. A straight wall does not need the compensation gasket. In this case apply silicone caulking to the vertical connection (distance wall / glass min. 3 mm).

